

Startup
Guide

Keysight
RF PA/FEM
Characterization & Test,
Reference Solution

Notice: This document contains references to Agilent. Please note that Agilent's Test and Measurement business has become Keysight Technologies. For more information, go to www.keysight.com.

Notices

Copyright Notice

© Keysight Technologies 2013 - 2015

No part of this manual may be reproduced in any form or by any means (including electronic storage and retrieval or translation into a foreign language) without prior agreement and written consent from Keysight Technologies, Inc. as governed by United States and international copyright laws.

Manual Part Number

Y1299-90004

Published By

Keysight Technologies
Ground Floor and Second Floor, CP-11
Sector-8, IMT Manesar – 122051
Gurgaon, Haryana, India

Edition

Edition 2, July, 2015
Printed In USA

Regulatory Compliance

This product has been designed and tested in accordance with accepted industry standards, and has been supplied in a safe condition. To review the Declaration of Conformity, go to <http://www.keysight.com/go/conformity>.

Warranty

THE MATERIAL CONTAINED IN THIS DOCUMENT IS PROVIDED “AS IS,” AND IS SUBJECT TO BEING CHANGED, WITHOUT NOTICE, IN FUTURE EDITIONS. FURTHER, TO THE MAXIMUM EXTENT PERMITTED BY APPLICABLE LAW, KEYSIGHT DISCLAIMS ALL WARRANTIES, EITHER EXPRESS OR IMPLIED, WITH REGARD TO THIS MANUAL AND ANY INFORMATION CONTAINED HEREIN, INCLUDING BUT NOT LIMITED TO THE IMPLIED WARRANTIES OF MERCHANTABILITY AND FITNESS FOR A PARTICULAR PURPOSE. KEYSIGHT SHALL NOT BE LIABLE FOR ERRORS OR FOR INCIDENTAL OR CONSEQUENTIAL DAMAGES IN CONNECTION WITH THE

FURNISHING, USE, OR PERFORMANCE OF THIS DOCUMENT OR OF ANY INFORMATION CONTAINED HEREIN. SHOULD KEYSIGHT AND THE USER HAVE A SEPARATE WRITTEN AGREEMENT WITH WARRANTY TERMS COVERING THE MATERIAL IN THIS DOCUMENT THAT CONFLICT WITH THESE TERMS, THE WARRANTY TERMS IN THE SEPARATE AGREEMENT SHALL CONTROL. KEYSIGHT TECHNOLOGIES DOES NOT WARRANT THIRD-PARTY SYSTEM-LEVEL (COMBINATION OF CHASSIS, CONTROLLERS, MODULES, ETC.) PERFORMANCE, SAFETY, OR REGULATORY COMPLIANCE, UNLESS SPECIFICALLY STATED.

Technology Licenses

The hardware and/or software described in this document are furnished under a license and may be used or copied only in accordance with the terms of such license.

U.S. Government Rights

The Software is “commercial computer software,” as defined by Federal Acquisition Regulation (“FAR”) 2.101. Pursuant to FAR 12.212 and 27.405-3 and Department of Defense FAR Supplement (“DFARS”) 227.7202, the U.S. government acquires commercial computer software under the same terms by which the software is customarily provided to the public. Accordingly, Keysight provides the Software to U.S. government customers under its standard commercial license, which is embodied in its End User License Agreement (EULA), a copy of which can be found at <http://www.keysight.com/find/sweula>. The license set forth in the EULA represents the exclusive authority by which the U.S. government may use, modify, distribute, or disclose the Software. The EULA and the license set forth therein, does not require or permit, among other things, that Keysight: (1) Furnish technical information related to commercial computer software or commercial computer software documentation that is not customarily provided to the public; or (2) Relinquish to, or otherwise provide, the

government rights in excess of these rights customarily provided to the public to use, modify, reproduce, release, perform, display, or disclose commercial computer software or commercial computer software documentation. No additional government requirements beyond those set forth in the EULA shall apply, except to the extent that those terms, rights, or licenses are explicitly required from all providers of commercial computer software pursuant to the FAR and the DFARS and are set forth specifically in writing elsewhere in the EULA. Keysight shall be under no obligation to update, revise or otherwise modify the Software. With respect to any technical data as defined by FAR 2.101, pursuant to FAR 12.211 and 27.404.2 and DFARS 227.7102, the U.S. government acquires no greater than Limited Rights as defined in FAR 27.401 or DFAR 227.7103-5 (c), as applicable in any technical data.

Safety Notices

CAUTION

A CAUTION notice denotes a hazard. It calls attention to an operating procedure, practice, or the like that, if not correctly performed or adhered to, could result in damage to the product or loss of important data. Do not proceed beyond a CAUTION notice until the indicated conditions are fully understood and met.

WARNING

A WARNING notice denotes a hazard. It calls attention to an operating procedure, practice, or the like that, if not correctly performed or adhered to, could result in personal injury or death. Do not proceed beyond a WARNING notice until the indicated conditions are fully understood and met.

The following safety precautions should be observed before using this product and any associated instrumentation.

This product is intended for use by qualified personnel who recognize shock hazards and are familiar with the safety precautions required to avoid

possible injury. Read and follow all installation, operation, and maintenance information carefully before using the product.

WARNING

If this product is not used as specified, the protection provided by the equipment could be impaired. This product must be used in a normal condition (in which all means for protection are intact) only.

The types of product users are:

- Responsible body is the individual or group responsible for the use and maintenance of equipment, for ensuring that the equipment is operated within its specifications and operating limits, and for ensuring operators are adequately trained.
- Operators use the product for its intended function. They must be trained in electrical safety procedures and proper use of the instrument. They must be protected from electric shock and contact with hazardous live circuits.
- Maintenance personnel perform routine procedures on the product to keep it operating properly (for example, setting the line voltage or replacing consumable materials). Maintenance procedures are described in the user documentation. The procedures explicitly state if the operator may perform them. Otherwise, they should be performed only by service personnel.
- Service personnel are trained to work on live circuits, perform safe installations, and repair products. Only properly trained service personnel may perform installation and service procedures.

WARNING

Operator is responsible to maintain safe operating conditions. To ensure safe operating conditions, modules should not be operated beyond the full temperature range specified in the Environmental and physical specification. Exceeding safe operating conditions can result in shorter lifespans, improper module performance and user safety issues. When the modules are in use and operation within the specified full

temperature range is not maintained, module surface temperatures may exceed safe handling conditions which can cause discomfort or burns if touched. In the event of a module exceeding the full temperature range, always allow the module to cool before touching or removing modules from chassis.

Keysight products are designed for use with electrical signals that are rated Measurement Category I and Measurement Category II, as described in the International Electrotechnical Commission (IEC) Standard IEC 60664. Most measurement, control, and data I/O signals are Measurement Category I and must not be directly connected to mains voltage or to voltage sources with high transient over-voltages. Measurement Category II connections require protection for high transient over-voltages often associated with local AC mains connections. Assume all measurement, control, and data I/O connections are for connection to Category I sources unless otherwise marked or described in the user documentation.

Exercise extreme caution when a shock hazard is present. Lethal voltage may be present on cable connector jacks or test fixtures. The American National Standards Institute (ANSI) states that a shock hazard exists when voltage levels greater than 30V RMS, 42.4V peak, or 60VDC are present. A good safety practice is to expect that hazardous voltage is present in any unknown circuit before measuring.

Operators of this product must be protected from electric shock at all times. The responsible body must ensure that operators are prevented access and/or insulated from every connection point. In some cases, connections must be exposed to potential human contact. Product operators in these circumstances must be trained to protect themselves from the risk of electric shock. If the circuit is capable of operating at or above 1000V, no conductive part of the circuit may be exposed.

Do not connect switching cards directly to unlimited power circuits. They are

intended to be used with impedance-limited sources. NEVER connect switching cards directly to AC mains. When connecting sources to switching cards, install protective devices to limit fault current and voltage to the card.

Before operating an instrument, ensure that the line cord is connected to a properly-grounded power receptacle. Inspect the connecting cables, test leads, and jumpers for possible wear, cracks, or breaks before each use.

When installing equipment where access to the main power cord is restricted, such as rack mounting, a separate main input power disconnect device must be provided in close proximity to the equipment and within easy reach of the operator.

For maximum safety, do not touch the product, test cables, or any other instruments while power is applied to the circuit under test. ALWAYS remove power from the entire test system and discharge any capacitors before: connecting or disconnecting cables or jumpers, installing or removing switching cards, or making internal changes, such as installing or removing jumpers.

Do not touch any object that could provide a current path to the common side of the circuit under test or power line (earth) ground. Always make measurements with dry hands while standing on a dry, insulated surface capable of withstanding the voltage being measured.

The instrument and accessories must be used in accordance with its specifications and operating instructions, or the safety of the equipment may be impaired.

Do not exceed the maximum signal levels of the instruments and accessories, as defined in the specifications and operating information, and as shown on the instrument or test fixture panels, or switching card.

When fuses are used in a product, replace with the same type and rating for continued protection against fire hazard.

Chassis connections must only be used as shield connections for measuring circuits, NOT as safety earth ground connections.

If you are using a test fixture, keep the lid closed while power is applied to the device under test. Safe operation requires the use of a lid interlock.

Instrumentation and accessories shall not be connected to humans.

Before performing any maintenance, disconnect the line cord and all test cables.

To maintain protection from electric shock and fire, replacement components in mains circuits – including the power transformer, test leads, and input jacks – must be purchased from Keysight. Standard fuses with applicable national safety approvals may be used if the rating and type are the same. Other components that are not safety-related may be purchased from other suppliers as long as they are equivalent to the original component (note that selected parts should be purchased only through Keysight to maintain accuracy and functionality of the product). If you are unsure about the applicability of a replacement component, call an Keysight office for information.

WARNING

No operator serviceable parts inside. Refer servicing to qualified personnel. To prevent electrical shock do not remove covers. For continued protection against fire hazard, replace fuse with same type and rating.

PRODUCT MARKINGS:



The CE mark is a registered trademark of the European Community.



Australian Communication and Media Authority mark to indicate regulatory compliance as a registered supplier.

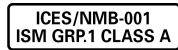

This symbol indicates product compliance with the Canadian Interference-Causing Equipment Standard (ICES-001). It also identifies the product is an Industrial Scientific and Medical Group 1 Class A product (CISPR 11, Clause 4).



South Korean Class A EMC Declaration. This equipment is Class A suitable for professional use and is for use in electromagnetic environments outside of the home. A 급 기기 (업무용 방송통신기자재) 이 기기는 업무용 (A 급) 전자파적합기기로서 판매자 또는 사용자는 이 점을 주의하시기 바라며, 가정외의 지역에서 사용하는 것을 목적으로 합니다.



This product complies with the WEEE Directive marketing requirement. The affixed product label (above) indicates that you must not discard this electrical/electronic product in domestic household waste. **Product Category:** With reference to the equipment types in the WEEE directive Annex 1, this product is classified as “Monitoring and Control instrumentation” product. Do not dispose in domestic household waste. To return unwanted products, contact your local Keysight office, or for more information see <http://about.keysight.com/en/companyinfo/environment/takeback.shtml>.



This symbol indicates the instrument is sensitive to electrostatic discharge (ESD). ESD can damage the highly sensitive components in your instrument. ESD damage is most likely to occur as the module is being installed or when cables are connected or disconnected. Protect the circuits from ESD damage by wearing a grounding strap that provides a high resistance path to ground. Alternatively, ground yourself to discharge any built-up static charge by touching the outer shell of any grounded instrument chassis before touching the port connectors.



This symbol on an instrument means caution, risk of danger. You should refer to the operating instructions located in the user documentation in all cases where the symbol is marked on the instrument.



This symbol indicates the time period during which no hazardous or toxic substance elements are expected to leak or deteriorate during normal use. Forty years is the expected useful life of the product.

CLEANING PRECAUTIONS:

WARNING

To prevent electrical shock, disconnect the Keysight Technologies instrument from mains before cleaning. Use a dry cloth or one slightly dampened with water to clean the external case parts. Do not attempt to clean internally. To clean the connectors, use alcohol in a well-ventilated area. Allow all residual alcohol moisture to evaporate, and the fumes to dissipate prior to energizing the instrument.

Contents

Contents	vii
Introduction	9
About the RF PA/FEM Characterization and Test, Reference Solution	9
Related Documentation	11
Items You Will Need	13
Step 1 - Unpack and Inspect the Modules	14
ESD	14
Inspect for Damage	15
Return an Instrument for Service	15
Verify Shipment Contents	16
Step 2: Install the PXI Modules	17
Before installing the PXI Modules	17
Precautions	17
Recommended best practices to ensure proper and safe module operating conditions	17
Cable and Connector Care	18
Prepare the Chassis	19
Install the Controller	20
Embedded Controller	20
Remote Controller	21
Install the M9381A and M9393A Instrument Modules	24
When installing each module:	24
PXI Module Slot Location	24
Cable the Instrument	26
Install Slot Blockers and Filler Panels	28
Power up the Chassis	28
Step 3: Install the Software	29
Requirements	29
Software Installation	30
Step 4: Redeem Your Software Licenses	32
Step 5: Verify Operation of the M9381A and M9393A	33
Communications	37
Step 6: Make a Measurement	38
Step 7: Installation is Complete	41
API Overview	41
IVI Drivers	41
LabVIEW Driver	42
Appendix 1: M9391A Information	43

Related Documentation	43
Module Slot Location for the M9381A and M9391A	43
M9391A Cable and Options Table	44
Appendix 2 Updating the M9300A FPGA	46
Reserving the Reference for a Configuration	46

Introduction

The scope of this document is to present the processes of receiving, installing, and verifying operation of the RF PA/FEM Characterization and Test, Reference Solution.

1. Unpack and inspect your shipment. Verify the contents of each box matches the respective contents list.
2. Install and cable the modules.
3. Install the software.
4. Redeem your software licenses.
5. Verify operation of the M9381A VSG and M9393A VSA.
6. Make a measurement with your M9381A VSG and M9393A VSA.
7. (Optional) Verify PA test configuration (includes connecting peripheral instruments for your PA test solution, such as Waveform generator, SMU, etc.).
8. Installation is complete. Proceed to use the Demo Tool and product drivers to develop your control programs.

About the RF PA/FEM Characterization and Test, Reference Solution

The RF PA/FEM Characterization & Test, Reference Solution provides a full characterization solution for design validation and product test of next generation power amplifiers and front end modules supporting cellular and wireless connectivity formats.

It performs S-parameter, harmonic distortion, power, and demodulation measurements utilizing envelope tracking (ET) and digital pre-distortion (DPD) optimization techniques.

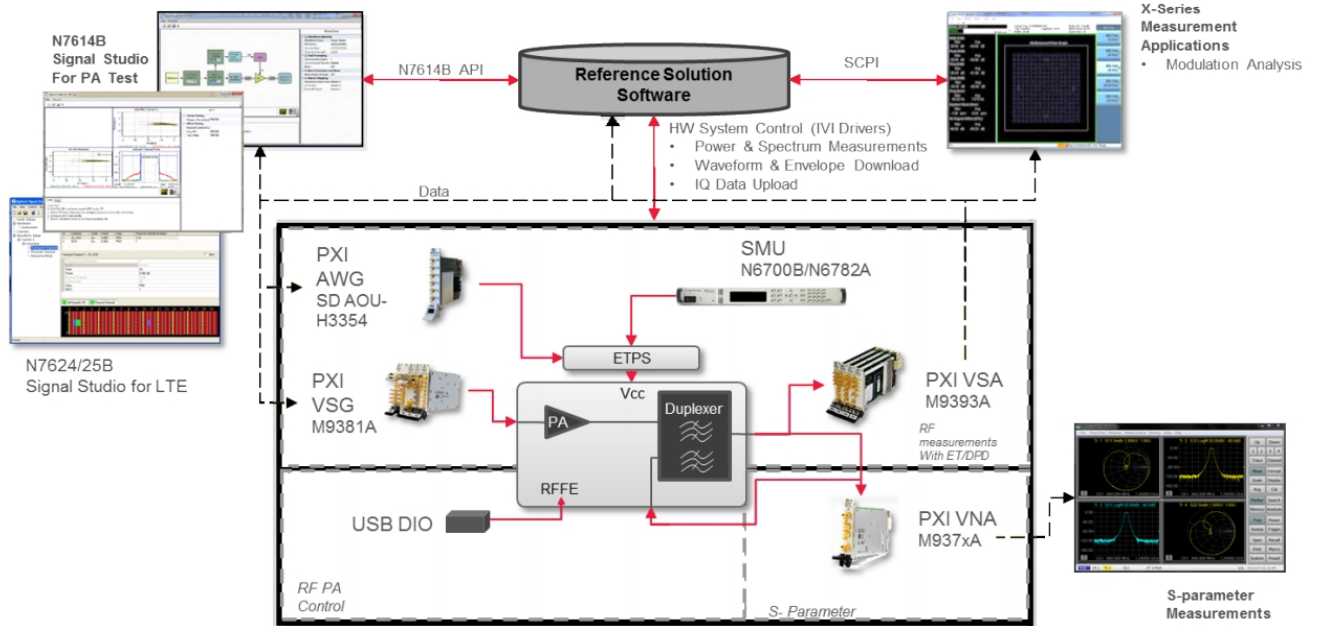

Related Documentation

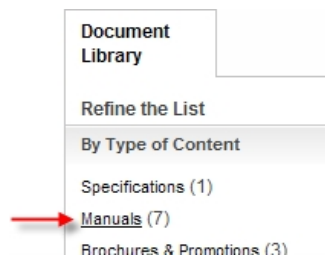

The documentation associated with this solution is available at the respective product pages on keysight.com (go to **Document Library > Manuals**).

M9381A Vector Signal Generator (see www.keysight.com/find/M9381A)

- M9381A VSG and M9391A VSA Startup Guide
- M9381A VSG and M9391A VSA Programming Guide
- M9381A Soft Front Panel help system
- M9381A device driver API references (IVI-C/IVI-COM and LabVIEW G)
- M9381A Data Sheet
- M9381A Specifications Guide

M9393A Vector Signal Analyzer¹ (see www.keysight.com/find/M9393A)

- M9393A Soft Front Panel help system
- M9381A VSG and M9391A VSA Startup Guide
- M9393A Startup guide
- M9381A VSG and M9391A VSA Programming Guide
- M9393A Programmers Guide
- M9393A device driver API references (IVI-C/IVI-COM and LabVIEW G)
- M9393A Data Sheet
- M9393A Security Guide

M937xA Vector Network Analyzer (see www.keysight.com/find/M9371A)

- M937xA User Manual
- M937xA Installation Manual
- M937xA Configuration Guide
- M937xA Help File

¹Refer to appendix 1 for M9391A information

M9018A PXIe Chassis (see www.keysight.com/find/M9018A)

- M9018A PXIe Chassis Startup Guide

M9036A or M9037A PXIe Embedded Controller

- M9036A PXIe Embedded Controller Startup Guide (optional) – see www.keysight.com/find/M9036A
- M9037A PXIe Embedded Controller Startup Guide (optional) – see www.keysight.com/find/M9037A

M9021A PCIe Cable Interface – optional (see www.keysight.com/find/M9021A)

- Keysight M9021A PCIe Cable Interface Module Installation Guide

Keysight Power Amplifier Test Demo Program

The "Power Amp Demo Program information and installation files are on the Y1299-10004 CD. The following documents are on the CD providing program instructions

- Keysight PXI Power Amplifier Test Demo Program User;s Guide
- Keysight PXI Power Amplifier Test Demo Program Developer Guide

Recommended Instruments and Software for Power Amplifier Test with Envelope Tracking

- Signadyne AWG-H3353 Arbitrary Waveform Generator (see <https://www.signadyne.com/en/search/?q=-h3353>)
- N6700B Power System Mainframe with N6782A Source/Measurement Unit (see www.keysight.com/find/N6700B and www.keysight.com/find/N6782A)
- U2004A Power Sensor (see www.keysight.com/find/U2004A)
- N7624B Signal Studio for LTE/LTE-Advanced FDD (see www.keysight.com/find/N7624B)
For other Keysight Signal Studio applications, see www.keysight.com/find/signalstudio.
- M9080B LTE/LTE-Advanced FDD
For other Keysight measurement applications for modular instruments, see www.keysight.com/find/M9080B.
- N7614B Signal Studio for PA Test (see www.keysight.com/find/N7614B)

Items You Will Need

To complete the startup process and begin using the solution, you will need the following items:

- Pozidriv P1 or slotted screwdriver to secure the modules into the chassis
- Adjustable torque wrench (at minimum, accommodate an 8 Lb-In [0.904 Nm] torque on SMA connectors).
- If your solution contains an embedded controller, such as the M9036A or M9037A:
 - Monitor with M9036A - Use the DVI-to-VGA adaptor (an accessory to the M9036A) if necessary. Monitor with M9037A - Use the Display Port to VGA adaptor (an accessory to the M9037A) if necessary.
 - USB compatible keyboard
 - USB compatible mouse
- If you are installing the software from CDs onto an embedded controller, you may wish to use a USB CD/DVD drive. As an alternative, copy the installer files to a computer, transfer the installer files to a USB flash drive, and install the software from the USB flash drive.
- A high-quality SMA (male) to SMA (male) cable at least 10 inches (25.4 cm) long. This cable is used in [Step 6: Make a Measurement \(page 38\)](#). If you are using a signal generator other than the Keysight M9381A PXIe Vector Signal Generator, the cable end at the signal generator RF Output may be different.

Step 1 - Unpack and Inspect the Modules

CAUTION

The modules are shipped in materials which prevent damage from static. Modules should only be removed from the packaging in an anti-static area ensuring that correct anti-static precautions are taken. Store all modules in anti-static envelopes when not in use.

ESD

Electrostatic discharge (ESD) can damage or destroy electronic components. Use a static-safe work station to perform all work on electronic assemblies. The figure (left) shows a static-safe work station using two types of ESD protection: conductive table-mat and wrist-strap combination, and conductive floor-mat and heel-strap combination. Both types, when used together, provide a significant level of ESD protection. Of the two, only the table-mat and wrist-strap combination provides adequate ESD protection when used alone. To ensure user safety, the static-safe accessories must provide at least 1 M Ω of isolation from ground.

WARNING

DO NOT use these techniques for a static-safe work station when working on circuitry with a voltage potential greater than 500 volts.

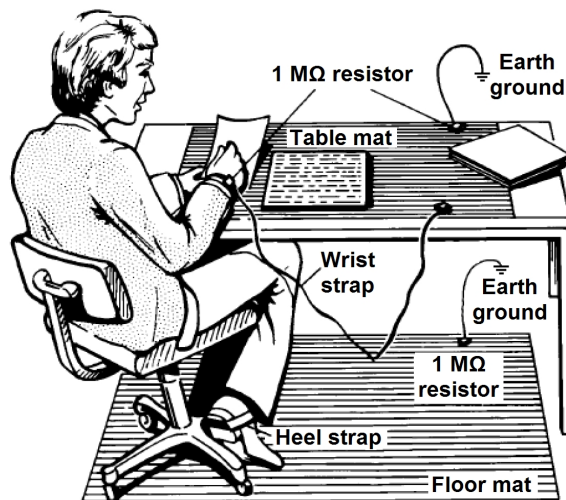

Inspect for Damage

After unpacking an instrument, inspect it for any shipping damage. Report any damage to the shipping agent immediately, as such damage is not covered by the warranty (see warranty information at beginning of this document).

CAUTION To avoid damage when handling a module, do not touch exposed connector pins

NOTE See www.keysight.com/find/tips for information on preventing damage to your keysight equipment.

Return an Instrument for Service

Should it become necessary to return an instrument for repair or service, follow the steps below:

NOTE It is recommended that you return all modules and cables of the M9381A or M9391A instrument for repair and calibration. If your Keysight M9300A PXIe Frequency Reference is operating properly, you need not send it in with the other modules because your instrument may be repaired and calibrated without your M9300A. Doing so, however, will effect your calibration schedule, since repairs are followed by calibration. The Calibration Due Date for your M9300A will not match the date of your other modules

1. Review the warranty information shipped with your product.
2. Contact Keysight to obtain a Return Material Authorization (RMA) and return address. For assistance finding Keysight contact information, go to www.keysight.com/find/assist.
3. Write the following information on a tag and attach it to the malfunctioning equipment:
 - Name and address of owner. A Post Office box is not acceptable as a return address.
 - Module serial number(s). The serial number label is located on the side panel of the module. The serial number can also be read from the Soft Front Panel interface - after the hardware is installed.
 - Description of failure or service required.
4. Pack the instrument in its original packaging. Include all cables. If the original packaging material is not available, use anti-static bubble wrap or packing

peanuts and place the instrument in a sealed container and mark the container -FRAGILE-.

5. On the shipping label, write ATTENTION REPAIR DEPARTMENT and the RMA number.

NOTE

In your correspondence, refer to the modules by serial number and the instrument by model number.

Verify Shipment Contents

Your solution will be shipped in multiple boxes. Refer to the box content list attached to each box.

Step 2: Install the PXI Modules

Proceed through this section in the following order:

1. Review “Before Installing PXI Modules” to understand installation guidelines and precautions.
2. Prepare the PXI chassis for the installation process.
3. Install the controller (embedded or external).
4. Install the modules.
5. Cable the instruments.
6. Install slot blockers and filler panels in the empty PXI chassis slots.
7. Power up the chassis.

Before installing the PXI Modules

Precautions

CAUTION PXI hardware does not support "hot-swap" (changing modules while power is applied to the chassis) capabilities. Before installing or removing a module to/from the chassis, power off the chassis to prevent damage to the module.

NOTE All component modules for an M9381A or M9393A instrument are factory tested, aligned, calibrated and shipped as a "bundle". It is important that you maintain the bundle when installing modules or returning an instrument for repair. See [Self Test Failure \(page 36\)](#)

Recommended best practices to ensure proper and safe module operating conditions

- Ensure proper chassis air flow is maintained
- Select a chassis that provides thermal protection if fans become inoperable or forced air cooling is obstructed
- Use slot blockers (Keysight model [Y1212A](#), 5 per kit) and EMC filler panels (Keysight model [Y1213A](#), 5 per kit) in empty module slots to ensure proper operating temperatures. [Keysight M9018A chassis](#) and slot blockers optimize module temperature performance and reliability of test.
- Set chassis fans to high or auto. Do not disable fans.
- Position chassis to allow plenty of space around chassis air intake and fan exhaust.
- At environment temperatures above 45 °C, set chassis fan speed to high.

Step 2: Install the PXI Modules
Before installing the PXI Modules

M9018A Chassis Air Flow



The M9018A has multiple air intakes. They are located at the lower sides, lower front and bottom of the chassis.

Cable and Connector Care



When you need to disconnect push-on cables from the module front panel connectors, use the Keysight Cable Removal Tool (PN 5002-3361) provided in your Keysight PXI instrument's ship kit .

To avoid damage to the cables or connectors, pull the cable straight away from the connector. Do not use the tool as a pry bar.

Prepare the Chassis

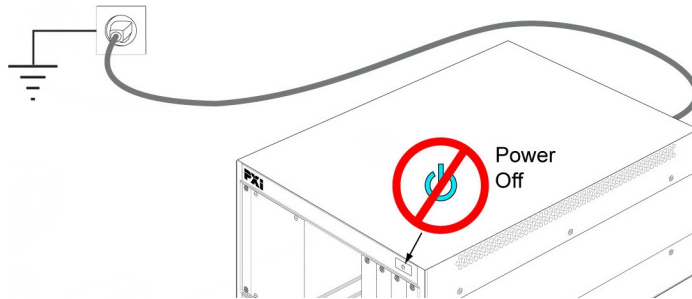

1. Make sure that the line cord is plugged into a grounded outlet to establish earth ground.
2. Make sure the chassis power switch is Off.
3. If the chassis has multiple fan speed settings, ensure that the fan switch is set to AUTO and the inhibit switch is set to DEF.



4. Position the chassis to provide ample space between the chassis fan intake and exhaust vents. Blockage by walls or obstructions affects the air flow needed for cooling.
5. Before inserting a module into the chassis, back the mounting screws out to ensure that there is no interference between the screws and the mounting rails.
6. Make sure the PXI chassis fans are operable and free of dust and other contaminants that may restrict airflow.

For additional information about setting up the M9018A chassis, refer to the [M9018A documentation](#)

Install the Controller

Use the appropriate instructions below for installing the embedded controller (Keysight models M9036A or M9037A) or remote controller (Keysight M9021A Cable Interface with M9045B adapter for laptop PC or M9048A adapter for desktop PC).

CAUTION Do not power up the controller until instructed to do so later in this document.

Embedded Controller

If your solution contains a Keysight M9036A or M9037A Embedded Controller, follow the procedure below. (For additional detail, refer to instructions in the [M9036A Startup Guide](#) or the [M9037A Startup Guide](#).)

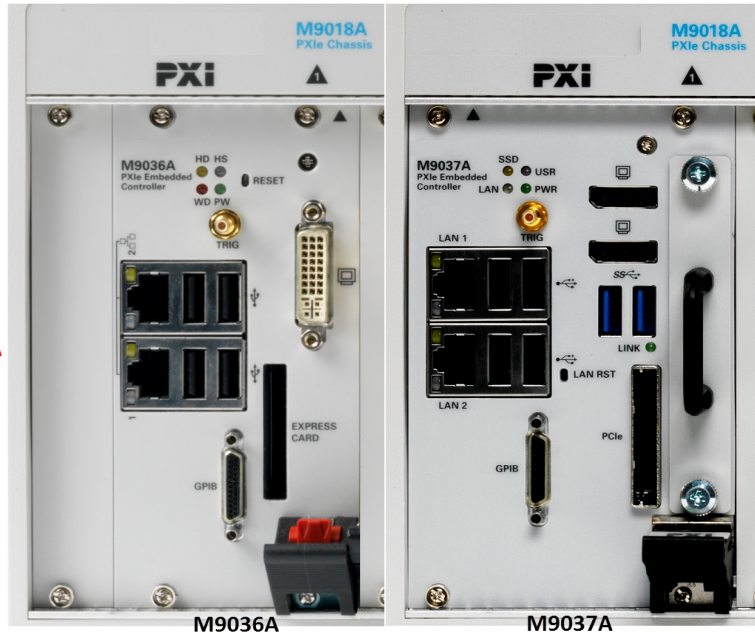

1. Remove the M9036A or M9037A module from its ESD protective bag. Observe [ESD precautions](#) (see page 14).
2. Install the embedded controller in Slot 1 (see  icon above the slot) in the chassis.

- a. While holding the module by the inject-or/ejector handle and making sure the inject-or/ejector handle is pushed down in the unlatched (downward) position, slide the controller

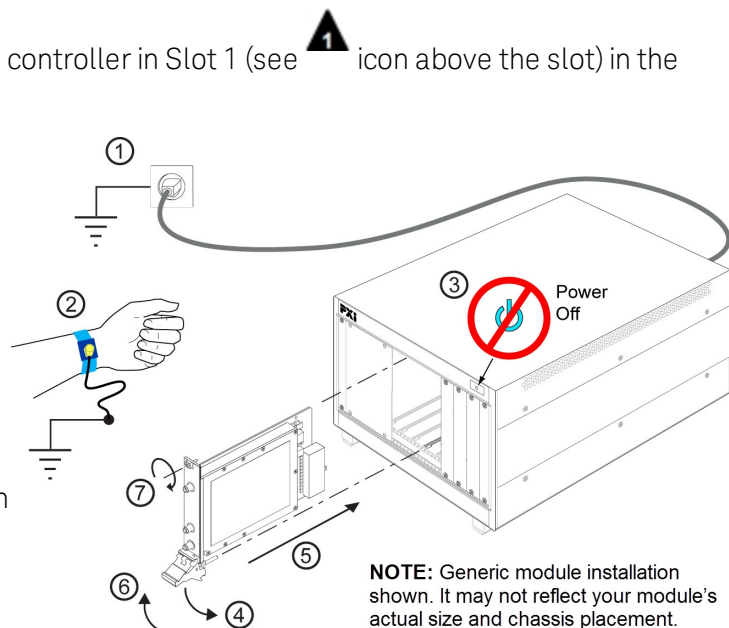

- module into chassis, using the slot guides (top and bottom).
 - b. Sliding the module into position, when you begin to feel resistance, pull up on the injector/ejector handle to fully inject the module into the chassis backplane connectors.
 - c. Tighten the module retaining screws (top and bottom) and torque them to 5 Lb-In (0.57 N-m).
3. If you have an M9036A controller, install a blank Y1213A filler panel in the empty slot to the left of the controller.
 4. Connect peripherals (mouse, keyboard, and monitor).

Remote Controller

If your solution contains a Keysight M9021A Cable Interface Module, follow the procedure below. For additional information about installing the M9021A, refer to the [M9021A Installation Guide](#).

NOTE

The following procedure addresses using the M9021A as a cabled PCIe interface between the M9018A chassis and an external host computer. **However**, if you intend to use an M9021A module to control a subordinate downstream chassis or RAID :

Install the M9021A in an x8 hybrid slot in the PXIe chassis (M9018A chassis slots 2, 6, 11, or 15).

Reverse the switch settings from those noted in this procedure: On the M9021A module, set both S301 switches to “Host” and set the S201 rocker switch to the left-hand position. On the M9018A chassis backplane, set the controller slot power-supply switch to the left.

-
1. Locate slot 1 in the chassis. It has the icon () above it.
 2. Set the M9018A chassis controller slot power supply switch to the right-hand position. This provides power to slot 1 for the benefit of the M9021A card.
 3. Remove the M9021A module from its protect bag. Observe [ESD precautions](#) (see page 14).
 4. On the M9021A module, set both S301 switches to the “Host” (right-hand) position and set the S201 rocker switch to the left-hand position.

Step 2: Install the PXI Modules
 Before installing the PXI Modules

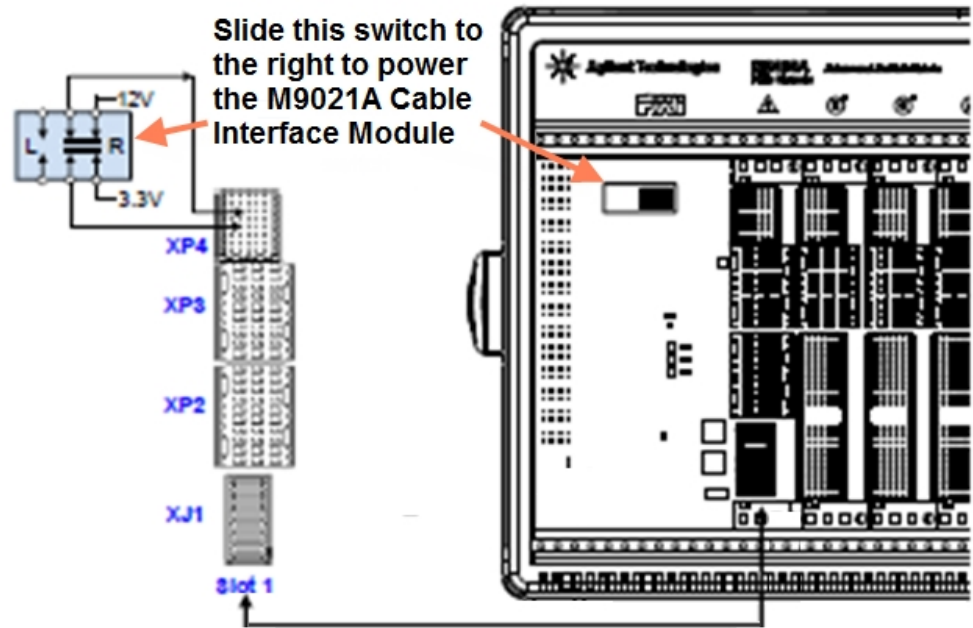

Refer to the following figure for M9021A switch locations and positions.

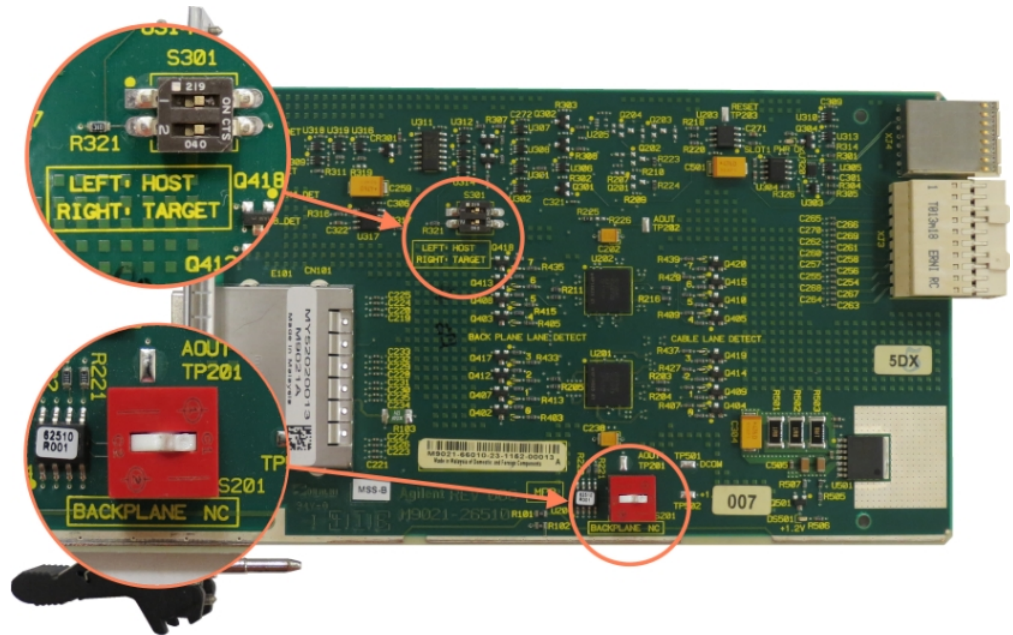

5. Install the M9021A Cable Interface Module into the chassis:
 - a. While holding the module by the injector/ejector handle and making sure the injector/ejector handle is pushed down in the unlatched (downward) position, slide the M9021A module into chassis, using the slot guides (top and bottom).
 - b. Sliding the module into position, when you begin to feel resistance, pull up on the injector/ejector handle to fully inject the module into the chassis backplane connectors.

- c. Tighten the module retaining screws (top and bottom) and torque them to 5 Lb-In (0.57 N-m).
6. Connect the M9021A to your laptop or desktop PC.
 - a. If you are using a laptop as a controller, connect to your M9021A using the following components:

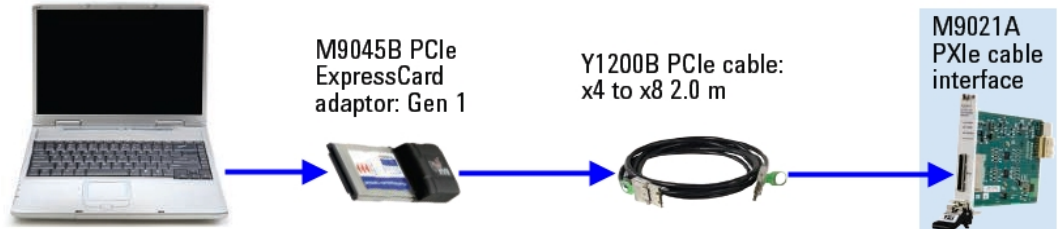

- b. If you are using a desktop PC as a controller, connect to the M9021A using the following components:

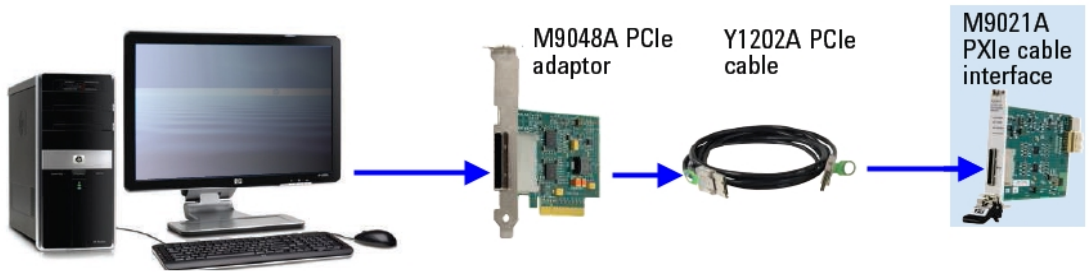

Install the M9381A and M9393A Instrument Modules

Plan your module positions. Install the left-most module first and then continue installing modules from left to right according to the following illustration.

When installing each module:

1. While holding the module by the injector/ejector handle and making sure the injector/ejector handle is pushed down in the unlatched (downward) position, slide the module into chassis, using the slot guides (top and bottom).
2. Sliding the module into position, when you begin to feel resistance, pull up on the injector/ejector handle to fully inject the module into the chassis backplane connectors.
3. Tighten the module retaining screws (top and bottom) and torque them to 5 Lb-In (0.57 N-m).

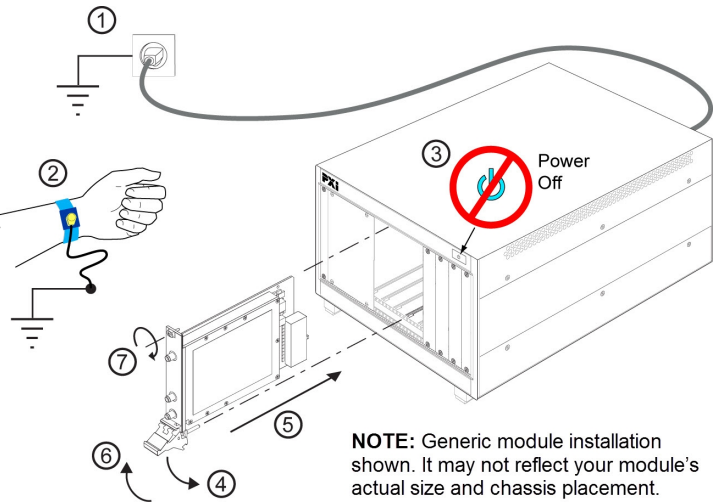

PXI Module Slot Location

M9381A with M9393A	
Slot #	Module
1	M9036A or M9037A Controller
2	M9311A
3	
4	M9310A
5	M9301A
6	M9214A
7	M9308A
8	M9365A
9	

10	M9300A
11	SD AWG-H3353 AWG
12	M9195A
13	M9375A VNA
14	M9375A VNA
15	M9451A

Cable the Instrument

M9381A Cable and Module Table (Listed in the recommended installation order)

Part Number	Connection	Cable Description
W1312-20266	M9301A RF/LO Out 1A to M9311A LO In	Cable, semi-rigid, SMA (male) - SMA (male)
W1312-20267	M9311A RF Out to M9310A RF In	Cable, semi-rigid, SMA (male) - SMA (male)
8120-5091	M9310A 100 MHz Out to M9311A 100 MHz In	Cable, coaxial, SMB (female) - SMB (female)
8120-5091	M9310A Trig 1 to M9311A Trig 1 for Pulse Mod.	Cable, coaxial, SMB (female) - SMB (female)
8120-5091	M9301A 100 MHz Out to M9310A 100 MHz In	Cable, coaxial, SMB (female) - SMB (female)
8120-5091	M9300A 100 MHz Out 1 to M9301A 100 MHz In	Cable, coaxial, SMB (female) - SMB (female)
1250-2316	M9310A RF Out connector saver	Adapter, coaxial straight SMA (male) - SMA (female)

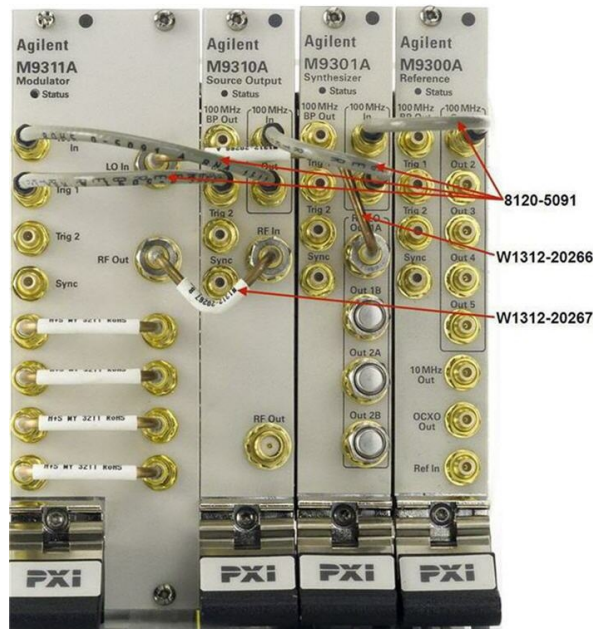

M9393A Cable and Module Table (Listed in the recommended installation order)

Part Number	Connection	Cable Description
M9365-20039	M9308A RF Out to M9365A 1st LO In	Cable, semi-rigid, SMA (male) - SMA (male)
M9365-20040	M9308A 4800 MHz Out to M9365A 2nd LO In	Cable, semi-rigid, SMA (male) - SMP (male)
1250-3807	M9214A 100 MHz In, left side of Tee to M9300A 100 MHz Out, right side to M9308A 100 MHz In	Adapter, T-type, SMB (male) - SMB (male) - SMB (female)
8121-2174	M9300A 100 MHz Out to M9214A 100 MHz In	Cable, coaxial, SMB (female) - SMB (female) 255 mm
8121-2169	M9365A IF Out to M9214A IF In	Cable, coaxial, SMB (female) - SMB (female) 165 mm
8121-2723	M9300A 100 MHz Out to M9308A 100 MHz In	Cable, coaxial, SMB (female) - SMP (female) 150 mm
8121-2554	M9308A 100 MHz Out to M9365A 100 MHz In	Cable, coaxial, SMP (female) - SMP (female) 150 mm
M9365-20042	M9365A Aux 2 Out to M9365A Aux 2 In	Cable, semi-rigid, SMA (male) - SMA (male) installed
M9365-20043	M9365A Aux RF Out to M9365A Aux RF In	Cable, semi-rigid, SMA (male) - 2.4 mm (male) installed
8121-2174	Alternate for 8121-2175	Cable, coaxial, SMB (female) - SMB (female) 120 mm
8121-2554	Alternate for 8121-2495	Cable, coaxial, SMB (female) - SMP (female) 240 mm
8121-2053	This cable can be used to direct an external reference into the M9300A Ref In connector.	Cable, coaxial, BNC (male) - SMB (female) 1200 mm

¹ This component is not shown in the cabling diagram, but is included in the M9393A shipment.

Step 2: Install the PXI Modules
Before installing the PXI Modules

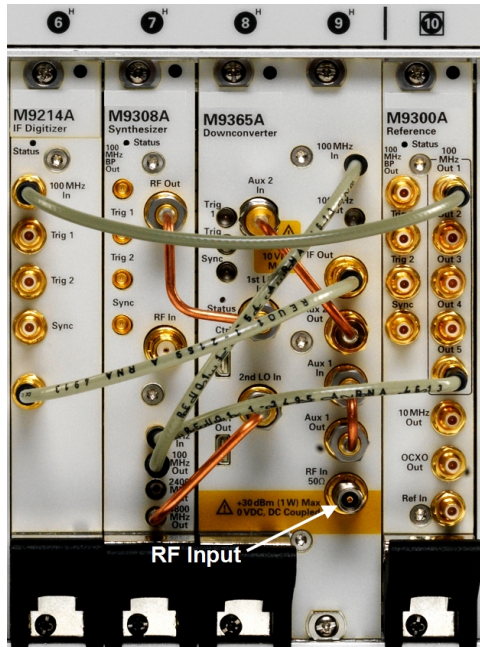

Install Slot Blockers and Filler Panels

To assure proper operating temperatures, install slot blockers (Keysight model [Y1212A](#), 5 per kit) and EMC filler panels (Keysight model [Y1213A](#), 5 per kit) in empty module slots.

Power up the Chassis

CAUTION

If you are using a remote controller, you must power up the chassis **BEFORE** you power up the PC. When you power down your solution, shut down the **PC BEFORE** you power down the chassis.

Step 3: Install the Software

Requirements

System	Requirements
Operating system	Windows 7 (32- & 64-bit), Windows Embedded Standard 7, Windows Vista (SP1 & SP2, 32- & 64-bit)
Processor speed	1 GHz 32-bit (x86), 1 GHz 64-bit (x64), no support for Itanium64
Available memory	4 GB minimum (8 GB recommended for 64-bit operating systems)
Available disk space	1.5 GB available hard disk space (includes 1 GB for Microsoft .NET Framework 3.5 SP1 4, and 100 MB for Keysight IO Libraries Suite)
Video	Support for DirectX 9 graphics with 128 MB graphics memory recommended (Super VGA is supported)
Browser	Microsoft Internet Explorer 7.0 or greater

Hardware	Requirements
Controllers	A PXI or PXI Express embedded controller or remote controller (external PC connected to the chassis by a PCI-to-PXI interface) is required.
Embedded controller	Keysight M9036A or M9037A or an embedded controller that meets the following requirements: <ul style="list-style-type: none"> - PXIe system controller (PXI-1 embedded controllers are not compatible) - Utilize a 2x8, or 4x4, PXIe system slot link configuration. - Run one of the operating systems listed in System Requirements (above).
Remote controller	(Keysight M9018A chassis only) A PC running one of the operating systems listed in System Requirements above and a Keysight M9021A Cable Interface x8 with one of the following PC interface options: <ul style="list-style-type: none"> - Keysight M9045B PCIe ExpressCard Adaptor x1, with cable (for a laptop PC) - Keysight M9048A PCIe Desktop Adaptor x8, with cable (for desktop PCs)

Due to the Microsoft end of support for Windows XP, M9393A is not supported on Windows XP. At the time of release 1.1 there were no known major problems running on Windows XP. However if you encounter an issue unique to Windows XP, Keysight may not attempt to address the issue.

Software Installation

Install the software in the order indicated in the following table into the embedded controller, or PC if your solution contains an M9021A PXIe Cable Interface.

Restart your controller when prompted by the respective software installer.

CAUTION

If you are using a remote controller, use this sequence to restart the PC and chassis:

- 1) Shut down the PC.
- 2) Power down the chassis.
- 3) Power up the chassis.
- 4) Power up the PC.

Order	Software	
1 *	Keysight IO Libraries Suite version 16.3 Update or newer; includes Keysight Connection Expert	www.keysight.com/find/iosuite
2 *	M9018A 18 Slot PXIe Chassis Drivers	www.keysight.com/find/M9018A www.keysight.com/find/m9018a-driver
3	M9393A PXIe Vector Signal Analyzer (version 1.0 or newer)	www.keysight.com/find/M9393A-driver
4	M9381A PXIe Vector Signal Generator version 1.4.400.0 or newer)	www.keysight.com/find/M9381A www.keysight.com/find/m9381a-driver
5	N7624B Signal Studio for LTE/LTE-Advanced FDD (optional)	www.keysight.com/find/M7624B
6	M9080B LTE FDD Measurement Application (optional)	www.keysight.com/find/M9080A
7	M937xA PCIe VNA (Version 1.0 or newer)	www.keysight.com/find/M9371A
8	M9195A Digital Stimulus/Response	www.keysight.com/find/M9195A
9	M9451A Measurement Accelerator	www.keysight.com/find/M9451A
10	M7614B Signal Studio for PA Test (optional)	www.keysight.com/find/M7614B
11	Signadyne SD AWG-H3353 PXIe AWG.(version 1.56.20 or higher	https://www.signadyne.com/en/search/?q=-h3353
12	Y1299A Start-up Kits	www.keysight.com/find/Y1299A
13	Cycle power to ensure the drivers are registered and the software is activated. It will save time to cycle power after all drivers are installed, instead of do so after each individual driver installation.	

Order	Software
-------	----------

NOTE: If you are using a remote controller, use this sequence to restart the PC and chassis:

- 1) Shut down the PC.
- 2) Power down the chassis.
- 3) Power up the chassis.
- 4) Power up the PC.

* Software that is already installed if you ordered the M9036A or M9037A Embedded Controller.

Step 4: Redeem Your Software Licenses

The basic software required to operate your solution requires no license. This includes:

- Keysight IO Libraries Suite
- Keysight M9381A VSG Software
- Keysight M9393A VSA Software
- Keysight M937xA VNA Software
- Keysight M9018A 18 Slot PXIe Chassis Drivers
- Keysight PXIe Power Amplifier Demo Software

Additional software may be included with your solution that requires licensing. For any additional licensed software products that you include in your solution you receive a Software Entitlement Certificate, for example:

- Keysight Signal Studio Applications Software
- Keysight Waveform 5 or 50 packs (optional)
- Keysight X-Series Measurement Applications for Modular Instruments (optional)
- Signadyne AWG-H3353. Arbitrary Waveform Generator. (licensing and software is free, goto www.signadyne.com)

For each of these licensed products, whether installed on your M9036A/M9037A Embedded Controller, or installed on your PC, you must redeem your license. Follow the instructions on your Software Entitlement Certificate to license and enable your new software.

Step 5: Verify Operation of the M9381A and M9393A

NOTE

If your system includes an M9391A instead of an M9393A, follow the procedure below, substituting M9391A in all places where M9393A is shown.

Use the following procedure to verify operation of a single channel VSG/VSA (M9381A and M9393A) configuration.

1. Turn power on to the M9018A Chassis, if you haven't already.
2. The step in this process is to conduct a Self Test of the M9381A and the M9393A.
 - a. Open the M9381A SFP by selecting **Start > All Programs > Keysight > M938x > M9381 SFP**.
 - b. Open the M9393A SFP by selecting **Start > All Programs > Keysight > M9393 > M9393 SFP**
 - c. For each SFP, you are presented with the "Connect to Instrument" dialog. Use **Ctrl/Select** to select all of the modules that are components of the M9381A and the M9393A, press **Connect** and the SFP opens. Leave the SFPs open. For example:

M9381A

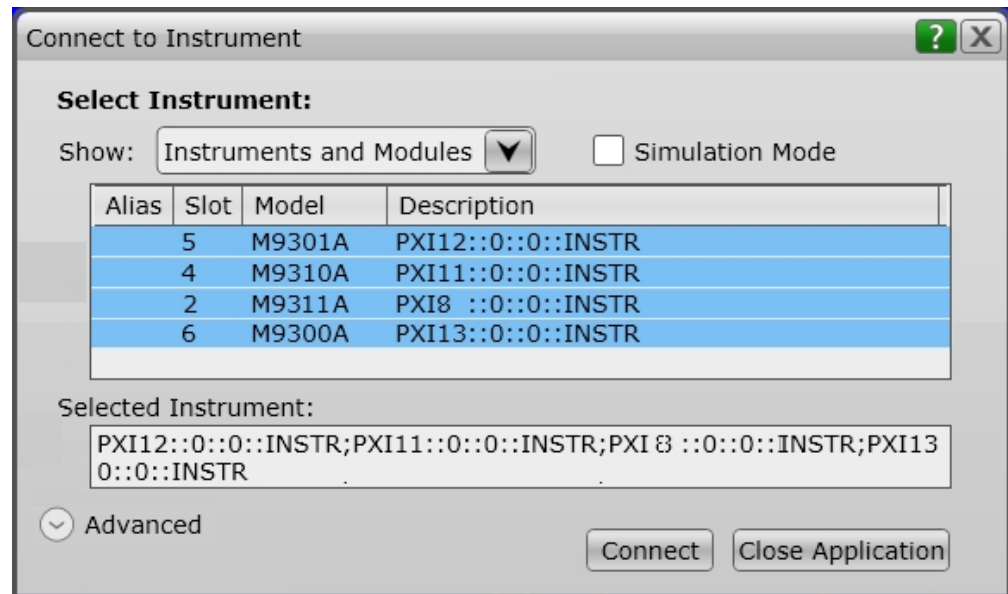

M9393A

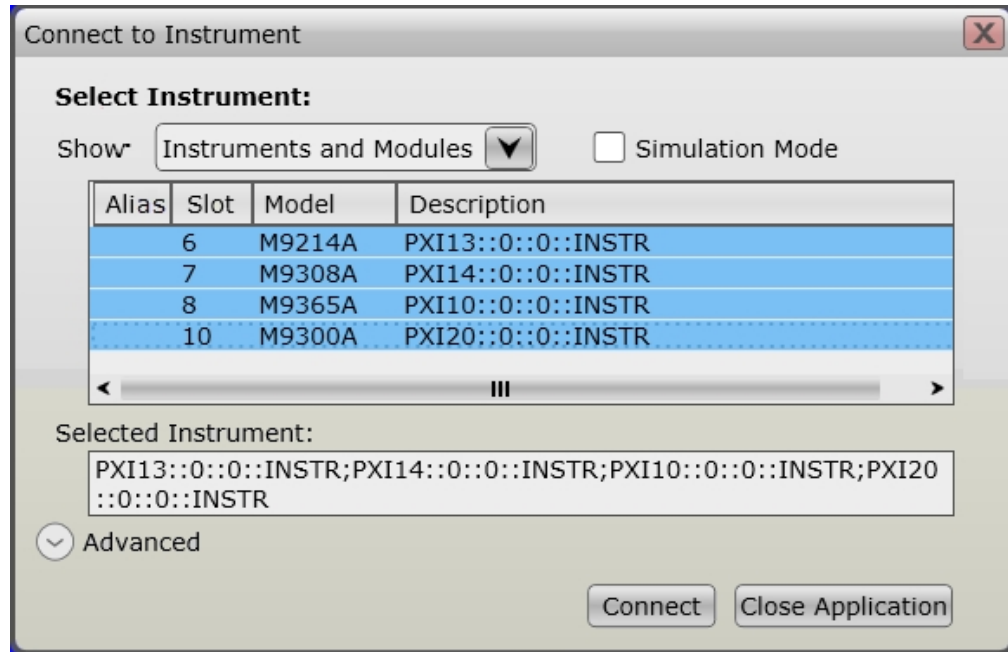

3. Check the front panel Status LEDs of all modules,.

Status LED States

Module	Green	Orange	Red	Off
M9300A	The Soft Front Panel has initialized the connection to the module	n/a	Indicates that the VCXO is unlocked.	<ul style="list-style-type: none"> Not connected by the SFP. Failure in the power supplies. Module hardware health can't be determined until the power supply failure is resolved.
M9301A	The Soft Front Panel has initialized the connection to the module	Tuning is in progress, or the M9301A is unlocked from the reference.	n/a	<ul style="list-style-type: none"> Not connected by the SFP. Failure in the power supplies. Module hardware health can't be determined until the power supply failure is resolved.
M9310A	The Soft Front Panel has initialized the connection to the module	n/a	n/a	<ul style="list-style-type: none"> Not connected by the SFP. Failure in the power supplies. Module hardware health can't be determined until the power supply failure is resolved.
M9311A	<ul style="list-style-type: none"> The Soft Front Panel has initialized the connection to the 	<ul style="list-style-type: none"> Modulation is turned on. 	<ul style="list-style-type: none"> DAC overload detected. IQ over- 	<ul style="list-style-type: none"> Not connected by the SFP. Failure in the power supplies. Module hardware health can't be determined until the power

Module	Green	Orange	Red	Off
	<p>module.</p> <ul style="list-style-type: none"> - The module has returned to idle from modulation. 		<p>load detected</p>	<p>supply failure is resolved.</p>
M9214A	The Soft Front Panel has initialized the connection to the module	Missing 100 MHz Reference.	n/a	<ul style="list-style-type: none"> - Not connected by the SFP. - Failure in the power supplies. Module hardware health can't be determined until the power supply failure is resolved.
M9308A	The Soft Front Panel has initialized the connection to the module	Tuning is in progress, or the M9308A is unlocked from the reference.	n/a	<ul style="list-style-type: none"> - Not connected by the SFP. - Failure in the power supplies. Module hardware health can't be determined until the power supply failure is resolved.
M9365A	The Soft Front Panel has initialized the connection to the module	Missing 100 MHz Reference.	n/a	<ul style="list-style-type: none"> - Not connected by the SFP. - Failure in the power supplies. Module hardware health can't be determined until the power supply failure is resolved.

4. Conduct a Self Test on all modules (Utilities > Self Test... > Run Self Test).

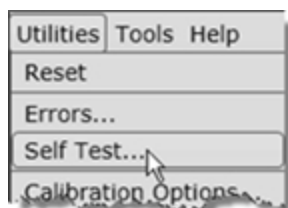

5. If the Self Test passes (see results below), go to [Step 6: Make a Measurement \(page 38\)](#).

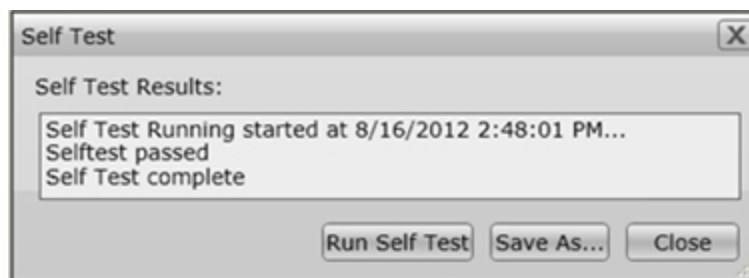

Self Test Failure

If the Self Test does not pass for any of the instruments, the test indicates which module is likely to need service. However, you should return all modules and all cables for that particular instrument.

To ensure that you send in the group of modules that was reported in a Self Test failure, go to **Utilities > Calibration Options...** to view this screen:

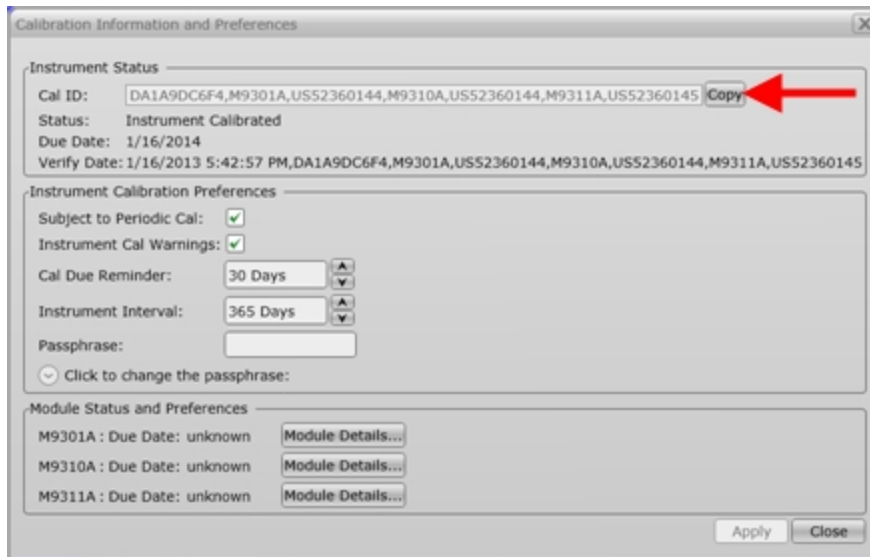

The string pointed out in this image is the Cal ID. The first 10 characters represent the Unique ID and the remaining characters show the modules (and their serial numbers) that constitute the M9381A or M9393A instrument. A Certificate of Calibration for that instrument contains the same information. Additionally, you may see this same information from the SFP by using Help > About.

Communications

If you are unable to communicate with the Keysight M9393A PXIe Performance Vector Signal Analyzer or M9381A verify that the following installations are correct:

- Keysight IO Libraries Suite
- M9381A and M9393A SFP programs
- Module and chassis drivers
- System Interface Card, cable and PC PXIe card connections, if you are using an external host PC

If not all modules and their slot locations are visible in the SFP "Connect to Instrument" dialog:

1. Close the SFP.
2. Start Keysight Connection Expert, by selecting **Start > All Programs > Keysight Connection Expert**. If any or all modules and their slot locations are still not visible, select **Refresh All**.
3. Restart the SFP.

Step 6: Make a Measurement

1. The first step in this process is to open the SFP of the M9381A and the M9393A.
 - a. Open the M9381A SFP by selecting **Start > All Programs > Keysight > M938x > M9381 SFP**.
 - b. Open the M9393A SFP by selecting **Start > All Programs > Keysight > M9393 > M9393 SFP**.
 - c. For each SFP, you are presented with the "Connect to Instrument" dialog. Use **Ctrl/Select** to select all of the modules that are components of the M9381A and the M9393A and press **Connect**.
2. Connect a high quality SMA (male) to SMA (male) cable between the RF Out connector on the Keysight M9310A PXIe Source Output and the RF In connector on the M9365A.
3. Torque the connectors to 8 Lb-In (0.904 Nm).
4. On the M9381A SFP make the following settings:
 - a. Frequency: 2 GHz
 - b. Amplitude: -10 dBm
 - c. RF On: checked

d. ALC On: checked.

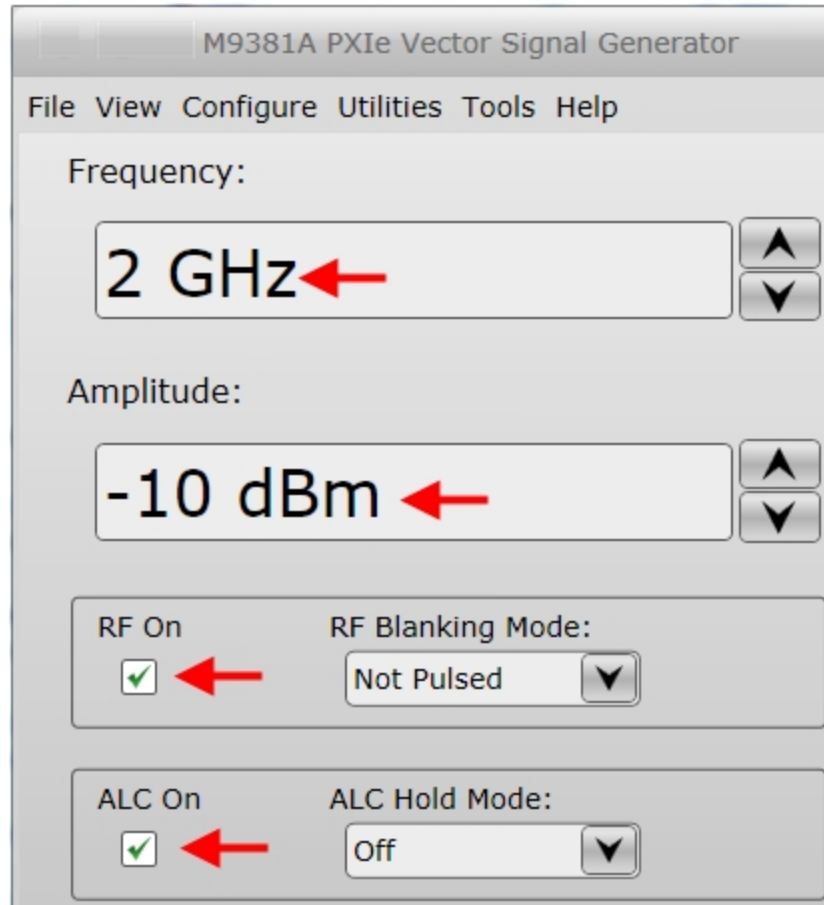

5. On the M9393A SFP Measure Tab, make the following settings:
 - a. Frequency: 2 GHz
 - b. Input Power: -10 dBm
 - c. Acquisition: Spectrum

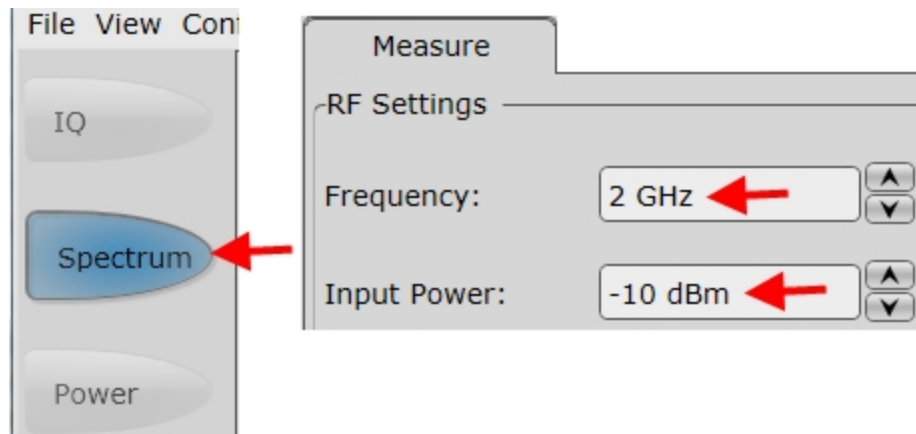

- Below the display, select Continuous for a sustained sweep of the analyzer.

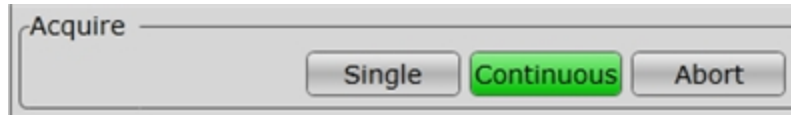

You should see the following display on your SFP. The frequency of the signal is 2 GHz and the amplitude is -10 dBm.

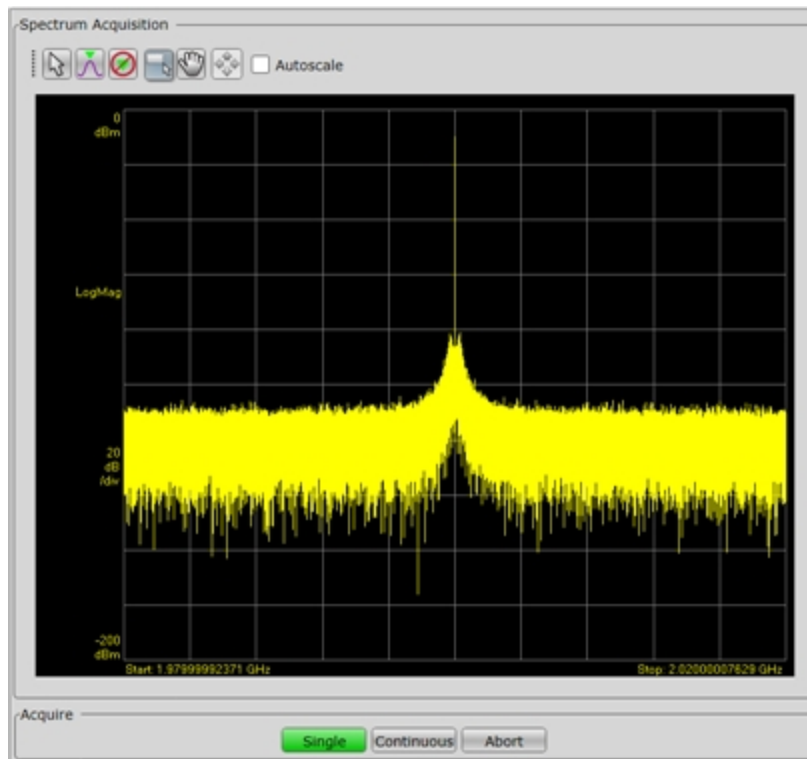

- Proceed to [Step 7: Installation is Complete \(page 41\)](#).

Step 7: Installation is Complete

- Use the Power Amplifier Test Demo Program to run provided waveforms (you must have Keysight Signal Studio license). This program can be installed to your PC by clicking on the software install button on the CD browser.
- Program with:
 - Power Amplifier Test Demo Program source code
 - Supported driver APIs for the products that comprise your solution

Proceed to program your product by means of the applications programming interface (API) for the supplied drivers.

API Overview

IVI Drivers

Keysight's IVI drivers simplify the creation and maintenance of instrument control applications in a variety of development environments; they allow programmatic control of instrumentation while providing a greater degree of instrument interchangeability and code reuse. IVI drivers currently come in two basic types: IVI-COM and IVI-C. Although the functionality offered by both types of drivers is often very similar, the fundamental differences in interface technology results in a very different end-user experience. The IVI drivers support compiling application programs for 32- or 64-bit platforms.

Supported ADEs (application development environments) Arguably the most important consideration in comparing IVI-COM and IVI-C drivers is the end user experience in various ADEs. Since IVI-COM drivers are based on Microsoft COM technology, it's not surprising that IVI-COM drivers offer the richest user experience in Microsoft ADEs. Users working in Visual C++, Visual C#, Visual Basic.NET, and Visual Basic 6 enjoy a host of features, such as object browsers, IntelliSense, and context-sensitive help.

When you install the product software, the IVI driver files are installed in the standard IVI Foundation directories (for example, C:\Program Files\IVI Foundation\IVI\Drivers\AgM938x). Example programs are provided to demonstrate most driver functionality (for example, C:\Program Files\IVI Foundation\IVI\Drivers\Examples). The reference material for the driver functions (a Microsoft HTML Help .chm file) is installed with the IVI driver and is available for Microsoft Visual Studio's IntelliSense context linking. In addition, you can directly access the .chm file (AgM938x.chm, AgM9391.chm, or AgM9393.chm) from this Start menu location: **Start > All Programs > Keysight IVI Drivers > AgM9393 > Documentation.**

LabVIEW Driver

In addition to the IVI drivers, Keysight provides a LabVIEW driver that includes all the functionality of the IVI-C driver. When you install the product software, the LabVIEW driver is installed to each LabVIEW instr.lib directory for each version of LabVIEW you have on your computer (for example, C:\Program Files (x86)\National Instruments\<LabVIEW version>\instr.lib\<Agilent product model>). If you install LabVIEW drivers before you install LabVIEW itself, drivers will be installed in the Agilent directory instead of the National Instruments directory (for example, C:\Program Files (x86)\Agilent\<Agilent product model>\LabVIEW Driver\<LabVIEW version>\...). Example programs are provided to demonstrate most driver functionality. The reference information for the driver (a Microsoft HTML Help .chm file) is also installed with the driver and the content is available from LabVIEW's Context Help window. In addition, you can directly access the chm file (AgM9391 LabVIEW_Help, or AgM9393 LabVIEW_Help) from this Start menu location: **Start > All Programs > Keysight > M9393 > AgM9393 Labview Help.**

Appendix 1: M9391A Information

Related Documentation

M9391A Vector Signal Analyzer (see www.keysight.com/find/M9391A)

- M9391A Soft Front Panel help system
- M9393A Soft Front Panel help system
- M9381A VSG and M9391A VSA Startup Guide
- M9391A or M9393A Startup guide
- M9381A VSG and M9391A VSA Programming Guide
- M9393A Programmers Guide
- M9391A device driver API references (IVI-C/IVI-COM and LabVIEW G)
- M9393A device driver API references (IVI-C/IVI-COM and LabVIEW G)
- M9391A Data Sheet
- M9391A Specifications Guide
- M9391A Security Guide

Module Slot Location for the M9381A and M9391A

M9381A with M9391A	
Slot #	Module
1	M9036A or M9037A Controller
2	M9311A
3	
4	M9310A
5	M9301A
6	M9214A
7	M9301A
8	M9350A
9	
10	M9300A
11	SD AWG-H3353 AWG
12	M9195A
13	M9375A VNA
14	M9375A VNA
15	M9451A

M9391A Cable and Options Table

M9391A Instrument Connections (Single M9391A VSA)

This section contains a cabling diagram for the Keysight M9391A PXIe Vector Signal Analyzer, a cable and module association table, a table of Front Panel Features for each module, and a block diagram for the M9391A, with reference tables for each module.

Part Number	Connections	Cable Description
1250-23161	M9350A RF In connector saver	Adaptor, coaxial straight SMA (male) - SMA (female)
8120-5091	M9300A 100 MHz Out 1 to M9301A 100 MHz In	Cable, coaxial, SMB (female) - SMB (female) 120 mm
8120-5091	M9301A 100 MHz Out to M9350A 100 MHz In	Cable, coaxial, SMB (female) - SMB (female) 120 mm
8120-5091	M9350A 100 MHz Out to M9214A 100 MHz In	Cable, coaxial, SMB (female) - SMB (female) 120 mm
8120-5091	M9350A IF Out to M9214A IF In	Cable, coaxial, SMB (female) - SMB (female) 120 mm
8121-20631	This cable can be used to direct an External Reference into the M9300A Ref In connector.	Cable, coaxial, BNC (male) - SMB (female) 1200 mm
W1312-20237 or W1312-20271	M9301A RF/LO Out 1A to M9350A LO In	Cable, semi-rigid, SMA (male) - SMA (male)

Option List for the Keysight M9391A PXIe Vector Signal Analyzer

M9391A Option	Description
M9391A-F03	Frequency Range, 1 MHz to 3 GHz
M9391A-F06	F06 Frequency Range: 1 MHz to 6 GHz
M9391A-UNZ	Fast Switching
M9391A-B04	Analysis Bandwidth, 40 MHz
M9391A-B10	Analysis Bandwidth, 100 MHz
M9391A-B16	Analysis Bandwidth, 160 MHz
M9391A-M01	Memory, 32 MSa
M9391A-M05	Memory, 512 MSa
M9391A-M10	Memory, 1024 MSa
M9391A-300	Add Keysight M9300A PXIe Frequency Reference: 10 MHz and 100 MHz
M9391A-UK6	Commercial calibration certificate with test data
M9391A-012	LO Sharing for Phase Coherency

Appendix 2 Updating the M9300A FPGA

CAUTION FPGA updates are not allowed on a Keysight M9300A PXIe Frequency Reference while it is being shared. To perform M9300A FPGA updates, reserve the Reference.

Reserving the Reference for a Configuration

If you are running a test in the background with a certain M9300A setting and then connect a hardware configuration that also contains the same M9300A, you may alter the test setup that is already running.

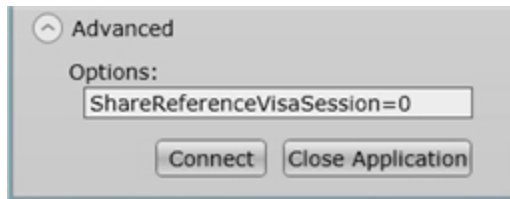

If you would prefer to keep the reference control with the first instance of the hardware configuration so that a subsequent instance will not take control of the reference module unintentionally:

1. On the SFP Connect to Instrument screen, click the Advanced control to open the Options: dialog.
2. Type the following string: `ShareReferenceVisaSession=0`

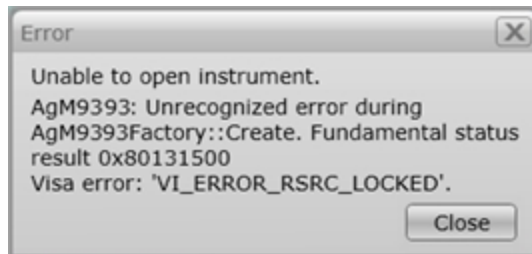

This configuration will retain control of the M9300A if you try to open a new configuration. If you connect a new configuration, that includes the same M9300A, you will see the following error:

CAUTION If an existing instance of the SFP is connected to the reference module in a shared (default) mode, and you try to connect a second instance of the SFP to the same reference with `ShareReferenceVisaSession=0` Advanced Option, you will get the resource locked error shown above.

This Page Intentionally Left Blank



This information is subject to change
without notice.
© Keysight Technologies 2013 - 2015
Edition 2, July, 2015
Printed In USA



Y1299-90004
www.keysight.com